



Series 06TR

6 mm Trimmer Potentiometer

- Terminals: tinned brass or tinned steel.
- Flexible gull-wing / through hole / "J" bend terminal configurations
- Various rotor types and with optional shaft & Wheel configurations
- IP 54 according to IEC 60529



Description

6 mm carbon potentiometers with plastic housing. Plastic materials can be self-extinguishable according to UL 94 V-0 upon request. This product is ideal for dimmers, volume/lighting regulation, timers and relays in industrial, electronics and automotive applications.

Ordering Information

Series	Rotor	Model	Taper	Resistance Value	Tol.	Terminal Material	Packg.	Special Request*		
06TR	1	A	A	101	A	P	R	Extra Features Assembled Accessories		
Rotor type (Page 4) 1: D-type 2: M-type 3: N-type 4: X-type		Model type (Page 4-6) A: H2.5 B: HSMD C: V2.5 D: V5 E: VS5 F: VSMD G: VESMD		Resistance Value 101=100Ω 201=200Ω ... 505=5MΩ		Terminal Material P: Tinned brass S: Tinned steel (Only available for Through-hole models)		Extra Features Life (standard 1,000 cycles) Track Housing Rotor Wiper		
			Taper A: Linear B: Logarithmic C: Antilogarithmic		Tol. A: ±5% B: ±10% C: ±20% D: ±25% E: ±30% F: +50%/-30%		Packaging Blank: Bulk R: Tape & Reel		Accessories Assembly (Shaft & Wheel) Ref# Color Flam Connect Operating temperature	

*Please contact CTS representatives for the special requests.

Standard Configuration	Through-hole	SMD
Dimensions:	6mm	
Protection:	IP 54 (high level of protection against dust and also against water splashing) On request: Self-extinguishable, to meet UL 94 V-0	
Substrate:	Carbon technology	Carbon technology (Special for high temperature)
Color:	Blue housing + white rotor	Brown housing + grey rotor
Packaging:	Bulk or Tape & Reel	
Wiper position:	at 50% ±15°	
Terminals: *	Snap in P (except model 06TRVS5)	---
Marking:	Resistive value marked on housing. Others on request.	

* By default, terminals are always crimped (with snap in, “SNP”) to better hold the component to the PCB during the soldering operation except VS5, with short terminals that do not allow for SNP. CTS can provide straight terminals if needed. Also, there is an option of having shorter terminal tips.

SNP

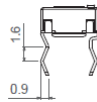

Electrical Specifications

	Through-Hole	SMD
Range of resistance values*		
Lin (A)	100Ω ≤ Rn ≤ 5MΩ	100Ω ≤ Rn ≤ 1MΩ
Log (B) Antilog (C)	1 KΩ ≤ Rn ≤ 2M2Ω	1 KΩ ≤ Rn ≤ 1 MΩ
Tolerance*:		
Rn < 100Ω:	+50%, -30% (out of range)	-
100Ω ≤ Rn ≤ 100KΩ	±20%	±25%
100K < Rn ≤ 1MΩ:	±20%	±25%
1MΩ < Rn ≤ 5MΩ:	±30%	±50%
Rn > 5MΩ:	+50%, -30% (out of range)	-
Residual Resistance	Rn ≤ 400Ω ≤ 2Ω; Rn > 400Ω 5*10 ⁻³ * Rn	
CRV - Contact Resistance Variation (dynamic)	Electrical Angle 215°±20° ≤ 3%Rn. Other tapers, please inquire	
Max Power Dissipation	at 50°C 0.10W-Lin(A) 0.06W -Log(B), Antilog(C)	
Max. Voltage	100VDC-Lin(A) 60VDC-Log(B), Antilog(C)	
Operating Temperature Range	-25°C to +70°C (+85°C on request)	
Temperature Coefficient		
100Ω ≤ Rn ≤ 10KΩ	+200 / -300 ppm	+200 / -500 ppm
10KΩ ≤ Rn ≤ 5MΩ	+200 / -500 ppm	+200 / -1000 ppm

* Out of range ohm values and tolerances are available on request.

Mechanical and Environmental

Actuation Life	1,000 cycles. On Request: Long Life
Angle of rotation (mechanical)	235° ± 10°
Angle of rotation (electrical)	215° ± 20°
Wiper standard delivery position	50% ± 15°
Max. stop torque	4 Ncm
Max. push/pull on rotor	9.8 N
Wiper Torque	< 2Ncm

Recommended Soldering Conditions (Lead free, RoHS compliant)

Manual soldering	Reflow soldering SMD	Flow (wave) soldering
Soldering tools of 20W max.	Preheating temperature: Max 150°C; 60-90 s	Recommended Alloy: SnAgCu
Maximum temperature of soldering tools: 280°C	Temperature Ramp-up: 2-3°C / s.	Preheating stage: Max 100°C; 30-60 s.
Time: 3 s. max.	Over 220°C;<40 s.	Temperature Ramp-up:1.2-2.5°C/s.
	Solder temperature: 240°C for 5 ± 1 s.	Max. wave temp.: 260°C for 4s., (245°C recommended)
		Time within +0°-10°C of peak: 10s.
		Cooling rate: 5°C/s.

Tapers

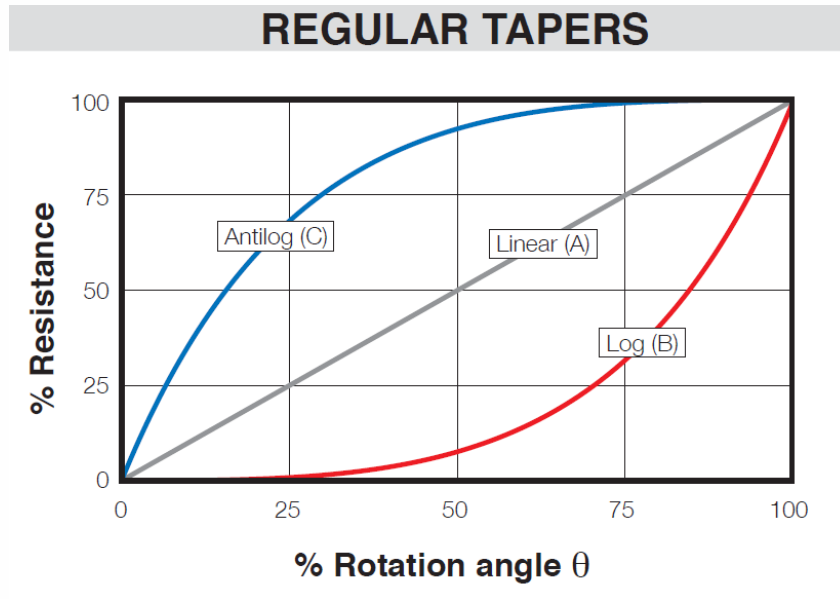

Mechanical Specifications

Rotor

Rotors are drawn in their standard positioning, 50% of rotation. Alternative delivery positioning can be requested. Accessories in this catalogue are designed for the X rotor, unless otherwise stated.

D-type

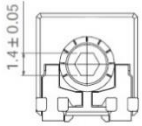

M-type

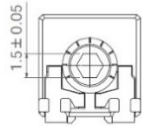

N-type

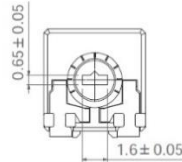

X-type

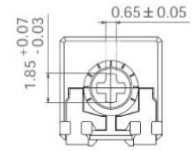

Surface Mount Gull Wing Terminal

HSMD

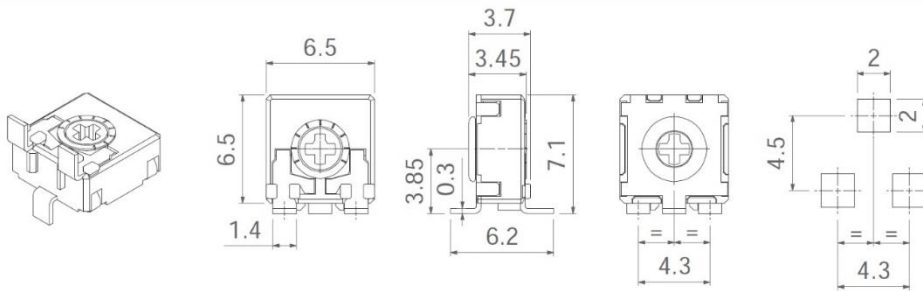

VSMD

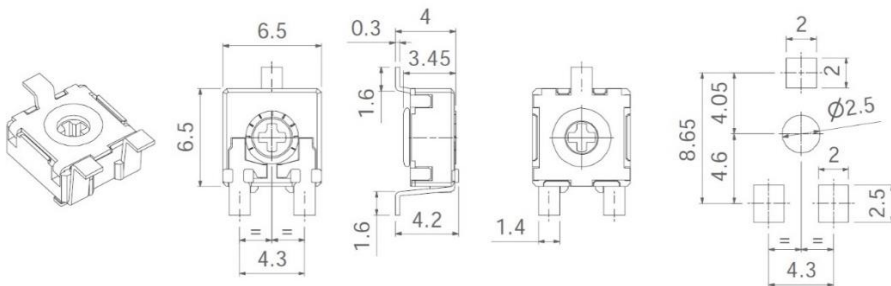

Surface Mount J-bend Terminal

VESMD

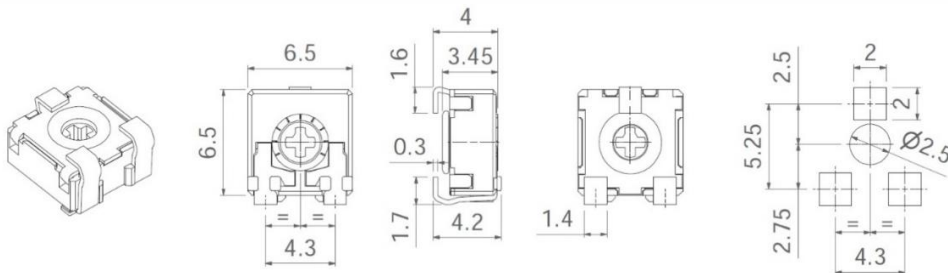

Thru-hole Terminal

H2.5

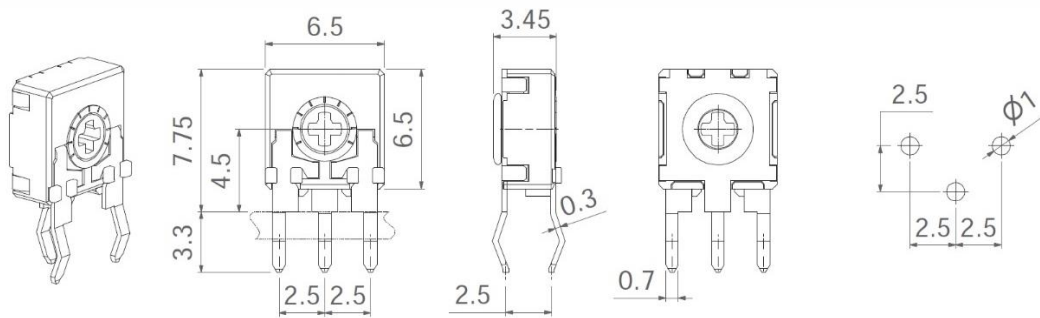

V2.5

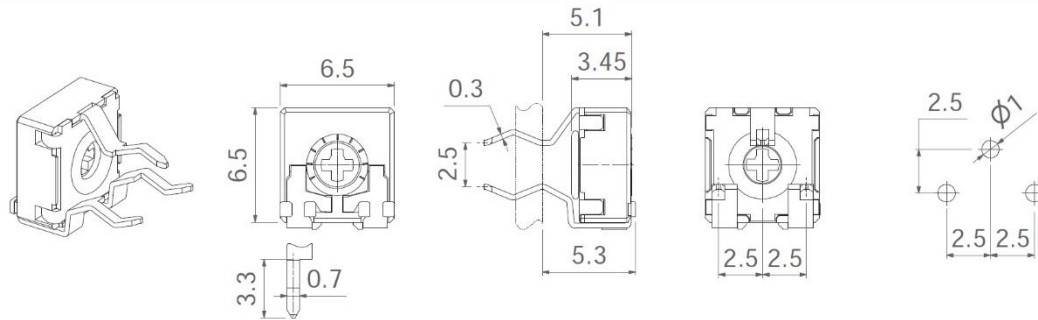

VS5

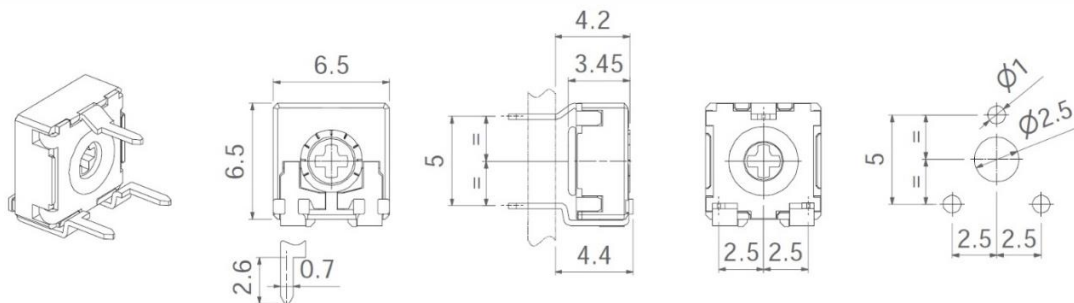

V5

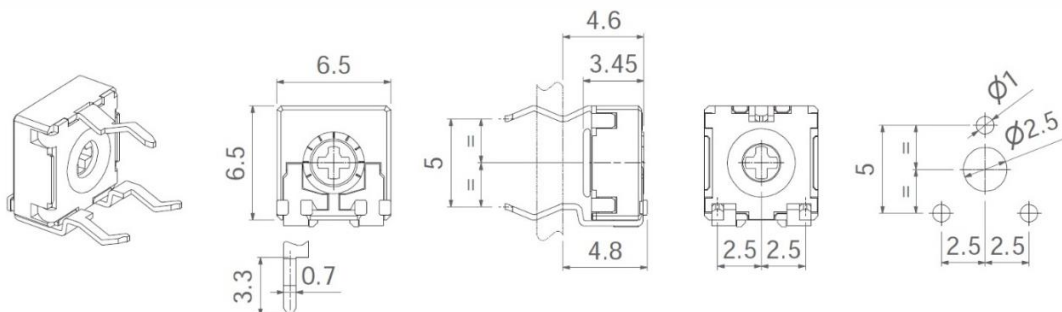

Shaft

Shafts are available in different colors and with self-extinguishable property, according to UL 94 V-0, under request. CTS can study special shaft designs.

Shafts can be sold separately or delivered already mounted on the potentiometer at CTS.

When a shaft is mounted, the distance from the top of the potentiometer to the top of the shaft is marked with “L” in the table below, as shown in the drawings:

H potentiometer + shaft

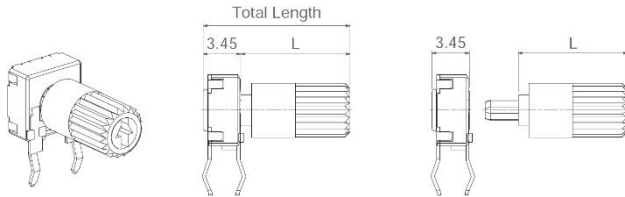

V potentiometer + shaft

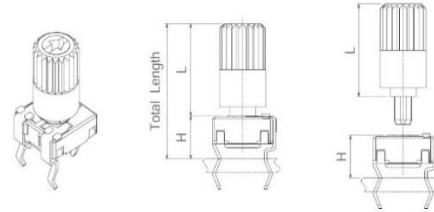

Shaft	6022	6023	6031	6024	6025	6028	6040
L Dimension	10	10	11	12.2	14.5	14.5	21.3

6022

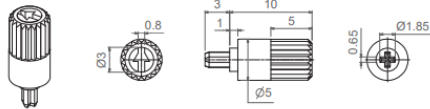

6023

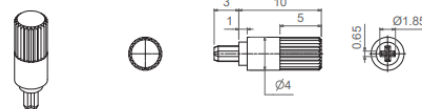

6024

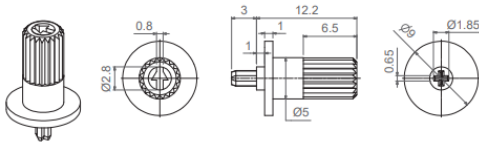

6025

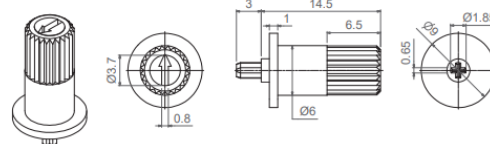

6028

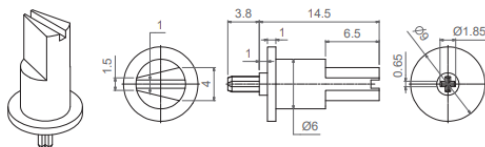

6031

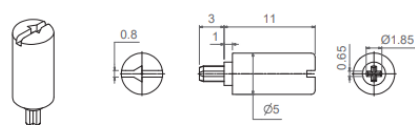

6040

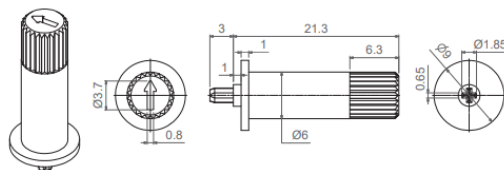

Wheel

Thumbwheels are available in different colors (color chart in “order information” section) and with self-extinguishable property according to UL 94 V-0, under request. Thumbwheels can be mounted on the potentiometers at CTS (see models with WT-6030 or WT-6037) or sold separately. CTS can study special thumbwheel designs.

6001

6001 **6030**

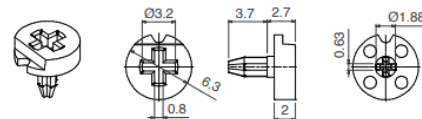
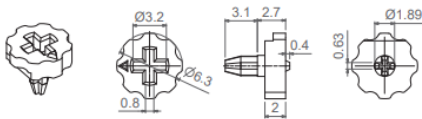

6032 **6034**

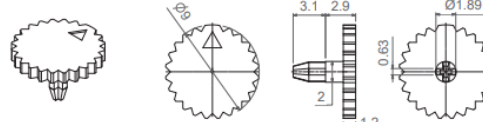
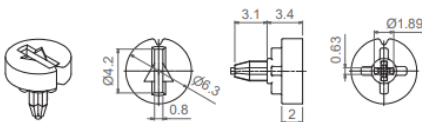

6035 (Designed for M rotor) **6037**

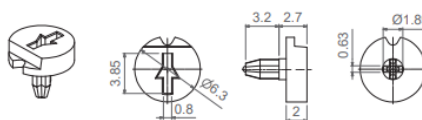
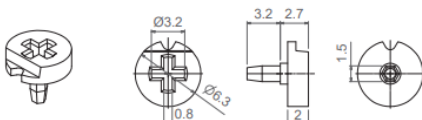

6043

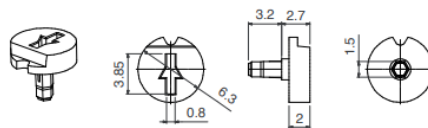

Packaging

Bulk packaging:	With shaft or thumbwheel inserted	Pieces per box
H2,5	None, only potentiometers.	3,000
V2,5 - V5 - VS5	None, only potentiometers.	2,500
HSM D - VSMD - VESMD	None, only potentiometers.	3,000
H2,5 - V2,5 - V5 - VS5 - HSM D - VSMD - VESMD	6001, 6030, 6032, 6035, 6037, 6043	2,000
	6024, 6025, 6028	500
	6022, 6023, 6031	1,250
Tape & Reel packaging:	With thumbwheel inserted?	13" Reel (Standard), with 24mm width tape
VSMD	None, only potentiometers.	1.200 pcs per reel, 12mm step between cavities.
	6030, 6035, 6037	750 pcs per reel, 12mm step between cavities.

VESMD	None, only potentiometers.	1.000 pcs per reel, 12mm step between cavities.
	6030, 6035, 6037	700 pcs per reel, 12mm step between cavities.
HSMD	None, only potentiometers.	750 pcs per reel, 12mm step between cavities.
	With specific thumbwheel.	Under request.
VS5...PIP	None, only potentiometers.	900 pcs per reel, 12mm step between cavities.

VSMD-T&R **VSMD-T&R...WT-6030 / 6035 / 6037**

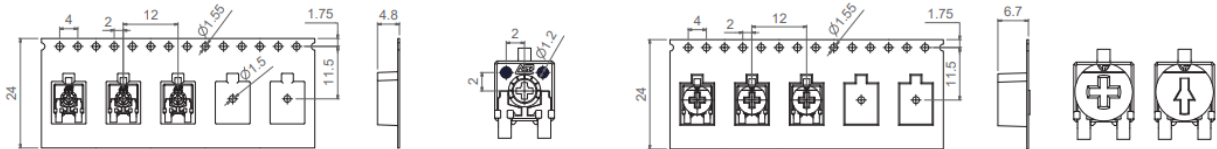

VESMD-T&R **VESMD-T&R...WT-6030 / 6035 / 6037**

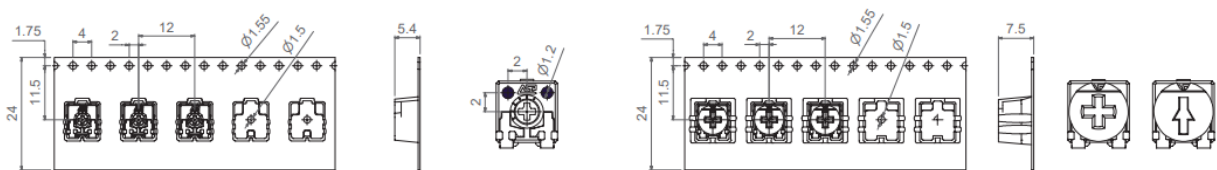

HSMD-T&R **VS5-T&R...PIP**

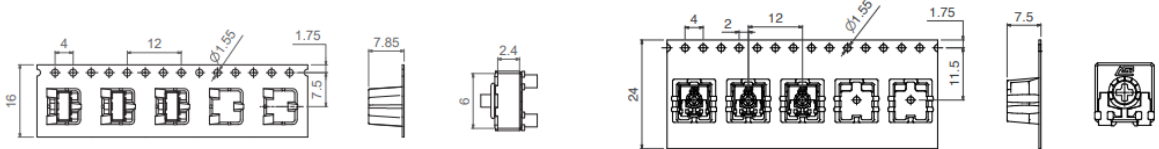

13" Reel

